

Thunder Link is a family of small form factor modules for formatting and converting generic digital video streams to standard compliant formats. Different interface standards are supported from the transmitter side including DVI/ HDMI, VGA, 3G-SDI, HD-SDI, SDI, CVBS and USB. Supported physical media are copper and fibre cables.

These modules connect to the digital video interface of Sony's FCB-EV, FCB-EH or compatible third party block cameras and support several progressive and interlace HDTV or SDTV formats. As no analog to digital conversion is done on these modules, excellent output image quality is achieved.

TL7051 - Features

- + Dual 3G/ HD-SDI outputs compliant to SMPTE424M / SMPTE292M
- + Supports Sony FCB-EV9500L/ EV7520/ EV7100/ EV7520A/ FCB-EH series
- + Digital 4Ch./ 8Ch. LVDS video input from camera
- + 1080p output at 60Hz, 59.94Hz, 50Hz, 30Hz, 29.97Hz and 25Hz
- + 720p output at 60Hz, 59.94Hz, 50Hz, 30Hz, 29.97Hz and 25Hz
- + 1080i output at 60Hz, 59.94Hz and 50Hz
- + Full automatic video input standard detection
- + Native digital signal processing chain for best image quality
- + Breakout of camera analog HDTV YPbPr and CVBS video*
- + RS232 and TTL level serial control interface
- + Robust RS485 differential serial control interface
- + Supply voltage 8V to 12V DC regulated
- + Temperature monitoring with alert function

* requires extended cable kit

Contact sales@aivion.com for information on additional block camera support.



Image for reference only.
TL7051 does not have a
HDMI connector assembled.

Block Diagram TL7051

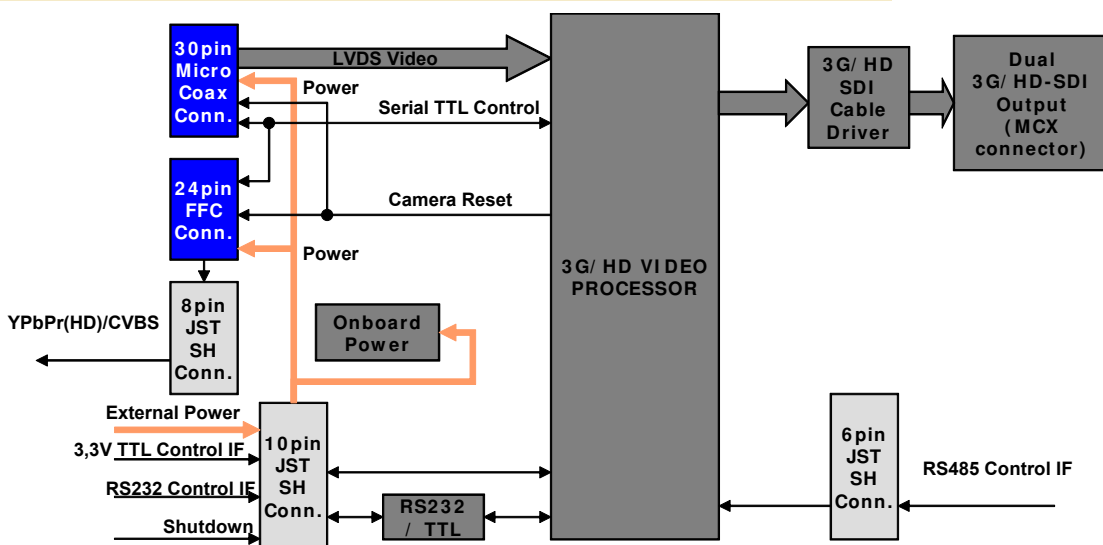

Order Codes:

TL7051

Dual 3G/ HD-SDI output

This datasheet is valid for all D Revision Boards.

Specification Camera Interface

INPUTS:

DATA 8/4 CH. LVDS digital video (from camera)
 CLOCK LVDS (from camera)
 CONTROL Rx 3.3V TTL serial control interface
 ANALOG YPbPr and CVBS video 1Vpp into 75 ohms

OUTPUTS:

CONTROL Tx 3.3V TTL serial control interface
 RESET 3.3V TTL, active low

Power and Environment

POWER INPUT:

8V to 12V DC regulated (13V DC absolute maximum)
 Power consumption (FCB-EV7520 + TL7051) 4.56W (cam motors inactive)

Power consumption value conditions:
 Power 12V DC, video mode 1080p59.94
 Ambient temperature +25°C/77°F
 Humidity 30%

OPERATING CONDITIONS:

Ambient temperature (min/max): -5°C/+60°C = 23°F/140°F
 Humidity: 20%-80%

STORAGE CONDITIONS:

Temperature (min/max): -20°C/+60°C = -4°F/140°F
 Humidity: 20%-80%

Board Mechanical

Mounting Holes:
 Diameter=2.6mm (1, 2)
 Diameter=3.2mm (3)

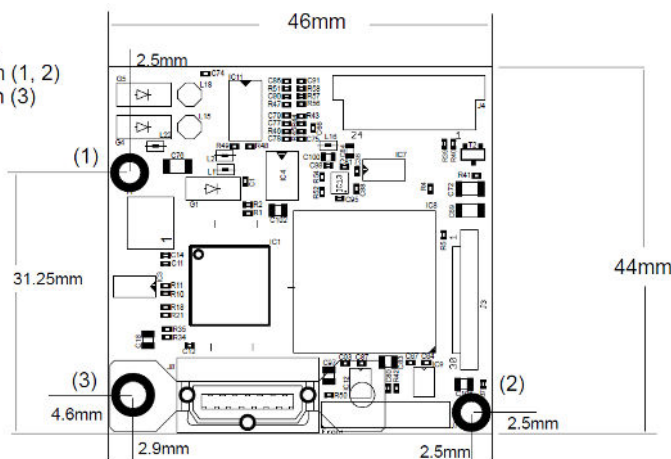

Maximum top component height = 3 mm

Maximum bottom component height = 6.8mm (MCX connectors)

PCB thickness = 1.56mm

Onboard Connectors

PCB Top Side:

24pin FFC Connector
 (Power, Reset, Serial Control IF, analog Video)
 J4

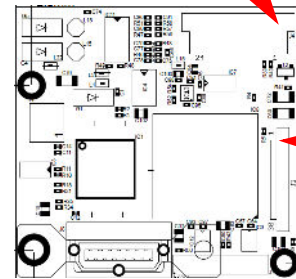

J3
 LVDS Video In,
 Power, Serial Ctrl,
 0.4mm Pitch Micro
 Coaxial Cable

TL7051 has no HDMI connector

PCB Bottom Side:

Dual 3G/HD-SDI output
 (MCX connector)
 J9 J10

YPbPr, CVBS
 Output
 J5
 Power
 RS232
 TTL
 Shutdown
 J1
 RS485
 J2

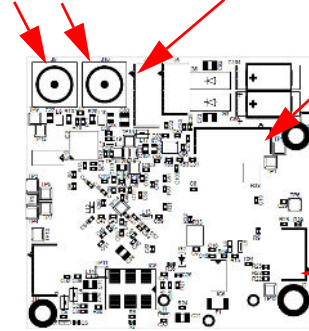

Note: Arrowheads indicate pin 1 location

J6: Do not connect
 J7: Do not connect
 J11: Do not connect

SAFETY NOTES:

FFC with contacts on SAME side MUST be used when connecting J4 of TL7051 to the camera.

All digital inputs are specified for maximum voltages of 3.3V (+5%).

Pin Assignment of external Interfaces

J1 JST BM10B-SRSS-TB

Power and RS232/ TTL Control IF

- 1 DC IN
- 2 DC IN
- 3 GND
- 4 GND
- 5 Reset / Shut Down, pull to GND to reset/shut down TL7050 and camera*
- 6 GND
- 7 TXD_TTL (serial IF transmit, 3.3V) and/or temperature alert output
- 8 RXD_TTL (serial IF receive, 3.3V)
- 9 RXD_232 (serial IF receive, RS232 level)
- 10 TXD_232 (serial IF transmit, RS232 level)

Note: Connect RS232 or TTL serial interface, not both

J5 JST BM08B-SRSS-TB, analog video from FCB-EHxxxx

Analog component YPbPr and CVBS output **

- 1 Pr
- 2 GND
- 3 Pb
- 4 GND
- 5 Y
- 6 GND
- 7 CVBS
- 8 GND

J4 24 pin FFC Connector, 0.5mm pitch, bottom contacts

J9, J10 75 ohms MCX coaxial jack

3G/ HD-SDI outputs

J2 JST BM06B-SRSS-TB

RS485 Control IF **

- 1 TXD_P (to controller)
- 2 TXD_N (to controller)
- 3 RXD_N (from controller)
- 4 RXD_P (from controller)
- 5 GND
- 6 3.45V typ. (max. current 50mA)

* for reset, pull to GND for one second or longer

** requires extended cable kit

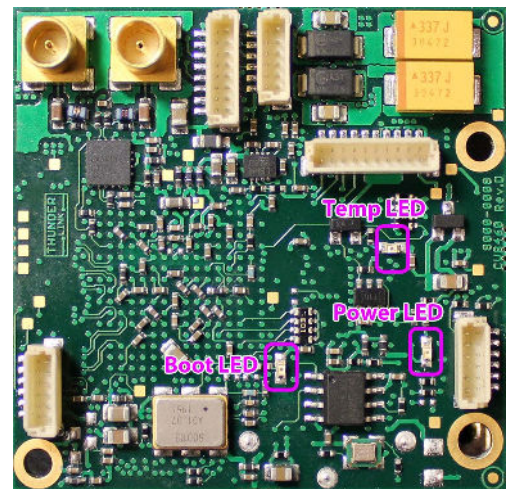

Onboard Mode Switches

Status LEDs

Switch	OFF (default)	ON
1 - cam select	FCB-EV cameras	FCB-EH
2 - cam control	RS232/TTL	RS485
3 - temp alert enable	no alert on J1/ pin7	J1/pin7 alert enabled
4 - mode	Camera	Test pattern*

Table 1: Onboard Switch Functions

* Refer to page 6 for test pattern generator operation



Power LED: ON as long as external DC power is applied.

Boot LED: Turns ON for 1sec after external DC power is applied, turns OFF when boot cycle is completed (~ 10sec).

Temp LED: See description of TempAlert Function on page 4 for details.

SAFETY NOTES: FFC with contacts on SAME side MUST be used when connecting J4 of TL7051 to the camera. All digital inputs are specified for maximum voltages of 3.3V (+ 5%).

Connection Diagram

FCB-EV type camera block

TL7051 top side

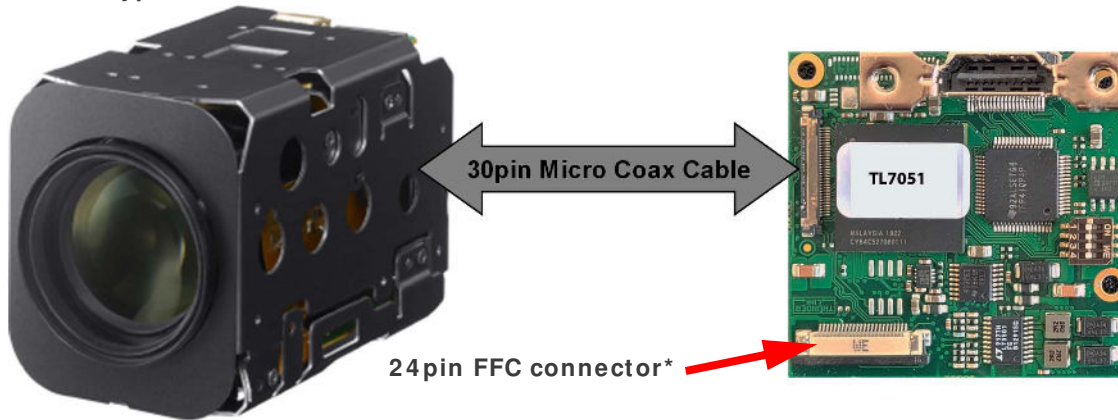

*** Notes:**

- TL7051 can be operated by using the 24pin FFC cable only if the selected camera model supports this interface.
- TL7051 can be operated by using the 30pin micro coaxial cable AND the 24pin FFC cable. In this case resistor R64 has to be removed.
- 30pin micro coaxial cable is included in TLCK-B base cable kit.

TL7051 bottom side

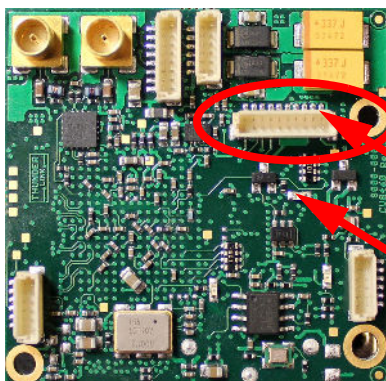

- J1
- Pin 1 location
- Temperature alert signalling LED (red colour when on)

R64 Removal

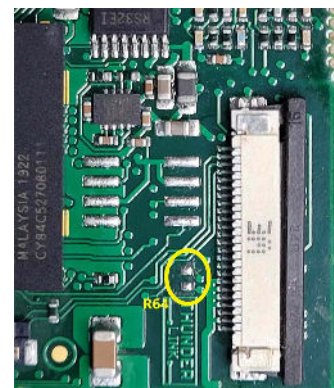

Single 4Ch / Dual 8Ch LVDS Camera Setting

When the camera is operated in 1080p60, 1080p59.94 or 1080p50 video monitoring mode, the LVDS output of the camera must be set to dual (8Ch) LVDS mode. For all other monitoring modes, it must be set to single (4Ch) LVDS mode. TL7051 supports LVDS clocks at 74.25MHz maximum. Please refer also to related camera documentation.

Temperature Alert Function

When board temperature exceeds 80°C (176°F), red LED will be switched on.

In addition such an event can be signalled on connector J1/pin7 by setting switch 3 (temp alert enable) to ON position.

- In case board temperature is equal to or over 80°C (176°F), level on J1/pin7 will be held constant low (< 0.4V)
- In case board temperature is less than 80°C (176°F), level on J1/pin7 will be high (> 2.4V)

SAFETY NOTES: FFC with contacts on SAME side MUST be used when connecting J4 of TL7051 to the camera. All digital inputs are specified for maximum voltages of 3.3V (+5%).

Analog Video Output

TL7051 provides analog HDTV YPbPr and analog SDTV CVBS video output signals. These signals are directly taken from the camera.

In some camera modes or for some camera models no or only limited analog video output support might be available. Please refer to the related camera documentation for details on respective analog video output capabilities.

Reset Operation

When applying power to TL7051, the camera is also automatically powered. During power up all functions on TL7051, are reset and initialized.

During operation a manual reset can be applied by pulling pin no. 5 of connector J1 to 0V (GND). This resets also the camera.

Camera Control

Camera control can be done by connecting a PC or CCU via RS485, RS232 or serial 3.3V TTL interface to TL7051. The interface is passed through to the camera that all VISCA protocol based software can be used.

Serial interface selection must be done by appropriate setting of switch-2.

Cable Kit Contents (Accessories)

TLCK-B-0200, Base cable kit:

External connecting cables:

1 pcs. - 10pin flying leads cable for power and control (RS232/TTL), lead length = 15cm / 5.9inch

Camera connecting cables:

1 pcs. - 30pin KEL USL type micro coaxial cable, connector on both sides, length = 20cm / 7.86inch

Extended cable kit for solutions with analog video breakout and RS485 support:

External connecting cables:

1 pcs. - 8pin flying leads cable for analog video, lead length = 15cm / 5.9inch

1 pcs. - 6pin flying leads cable for RS485, lead length = 15cm / 5.9inch

Camera connecting cables:

1 pcs. - 24pin flat flex cable, contacts on same side, pitch = 0.5mm, length = 10cm / 3.9inch

SAFETY NOTES: FFC with contacts on SAME side MUST be used when connecting J4 of TL7051 to the camera. All digital inputs are specified for maximum voltages of 3.3V (+5%).

Test Pattern Generator

TL7051 has an integrated test pattern generator (TPG) which can be operated independent of any camera. The TPG can be enabled by setting onboard switch number 4 to ON position and repowering the TL7051 board. In addition one out of two test pattern and one out of four video standards can be selected by setting onboard switches 1, 2 and 3 accordingly. The following tables summarize all details.

To enable TPG mode, please execute these steps:

1. Set video mode with switches 2 and 3
2. Set pattern with switch 1
3. Set switch 4 to ON to enable TPG mode
4. Switch TL7051 power off and on again

Note: TPG operation can be enabled with or without any camera connected to TL7051

Switch	OFF	ON
4 (TPG on/off)	Camera video output	TPG video output
1 (Pattern)	Multi test pattern	Stress test pattern

Table 4: TPG on/ off and pattern select

	Switch 3 OFF	Switch 3 ON
Switch 2 OFF	1080p 59.94Hz	1080p 50Hz
Switch 2 ON	1080p 29.97Hz	1080p 25Hz

Table 5: Video standard selection

Test Images

Multi Test Pattern



Stress Test



Stress test pattern generates worst case bit cycles on the serial 3G/HD-SDI link. It is suitable to check data/clock recovery performance of any connected 3G/HD-SDI receiver.