

Thunder Link is a family of small form factor modules for formatting and converting generic digital video streams to standard compliant formats. Different interface standards are supported from the transmitter side including DVI/ HDMI, VGA, 3G-SDI, HD-SDI, SDI, CVBS and USB. Supported physical media are copper and fibre cables.

These modules connect to the digital video interface of Sony's FCB-EV, FCB-H, FCB-EH or FCB-EX block cameras and support several progressive and interlace HDTV or SDTV formats. As no analog to digital conversion is done on these modules, excellent output image quality is achieved.

### TL7052 - Features

- + Supports Sony FCB-EV7500/ 7310/ 7300/ 7100/ 5500/ 5300
- + Supports all Sony FCB-EH camera blocks and FCB-SE600
- + Digital 4Ch./ 8Ch. LVDS video input from camera
- + 1080p and 720p output at 60Hz, 59.94Hz, 50Hz, 30Hz, 29.97Hz and 25Hz
- + 1080i output at 60Hz, 59.94Hz and 50Hz
- + Full automatic video input standard detection
- + 3G/ HD DVI video output over HDMI connector
- + Native digital signal processing chain for best image quality
- + Breakout of camera analog HDTV YPbPr and CVBS video\*
- + RS232 and TTL level serial control interface
- + Supply voltage 5V or 12V DC regulated
- + **NEW:** Temperature monitoring with alert function

\*requires TL705x extended cable kit



**3G/ HD  
DVI (HDMI)  
Output**

### Block Diagram TL7052

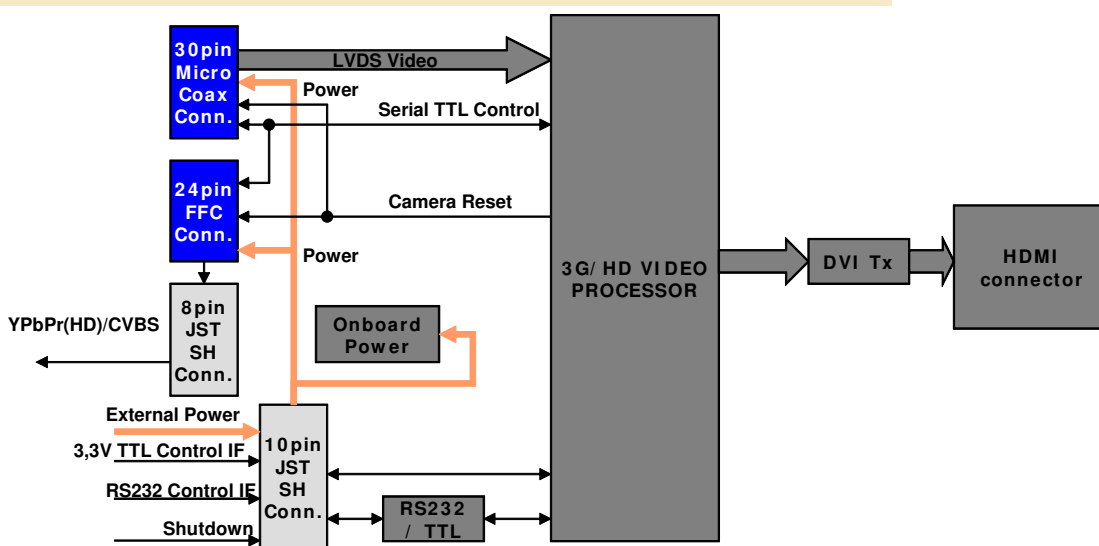

Order Codes:  
 TL7052  
 3G/ HD DVI (HDMI) output  
 TL705xCK-B  
 Base Cable Kit  
 TL705xCK-E  
 Extended Cable Kit

This datasheet is valid for all B Revision Boards.



## Specification Camera Interface

### INPUTS:

DATA 8/4 CH. LVDS digital video (from camera)  
 CLOCK LVDS (from camera)  
 CONTROL Rx 3.3V TTL serial control interface  
 ANALOG YPbPr and CVBS video 1Vpp into 75 ohms

### OUTPUTS:

CONTROL Tx 3.3V TTL serial control interface  
 RESET 3.3V TTL, active low

## Power and Environment

### POWER INPUT:

5V DC regulated (5.8V DC absolute maximum) when using FCB-SE600  
 7V to 12V DC regulated (13V DC absolute maximum) for other camera blocks  
 Power consumption (FCB-EV7500 + TL7052) 4.2W (cam motors inactive)  
 Power consumption (FCB-EV7100 + TL7052) 4.56 W (cam motors inactive)  
 Power consumption (FCB-EV5500 + TL7052) 3.96 W (cam motors inactive)

### Power consumption value conditions:

Power 12V DC, video mode 1080p59.94 (720p59.94 for FCB-EV5500)  
 Ambient temperature +25°C/77°F  
 Humidity 30%

### OPERATING CONDITIONS:

Ambient temperature (min/max): -5°C/+60°C = 23°F/140°F  
 Humidity: 20%-80%

### STORAGE CONDITIONS:

Temperature (min/max): -20°C/+60°C = -4°F/140°F  
 Humidity: 20%-80%

## Board Mechanical

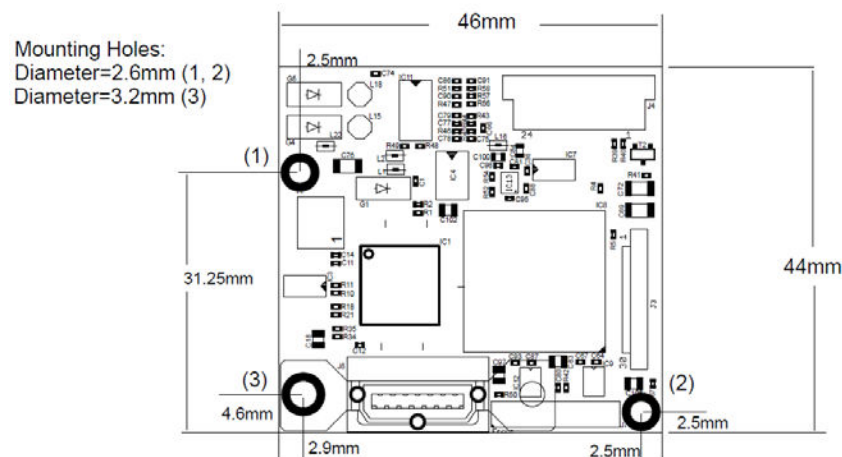

Maximum top component height = 10.5mm (HDMI connector)

Maximum bottom component height = 3.5mm

PCB thickness = 1.56mm

### POWER INPUT:

5V DC regulated (5.8V DC absolute maximum) when using FCB-SE600  
 7V to 12V DC regulated (13V DC absolute maximum) for other camera blocks

## Onboard Connectors

### PCB Top Side:

24pin FFC Connector  
 (Power, Reset, Serial Control IF, analog Video)  
 J4

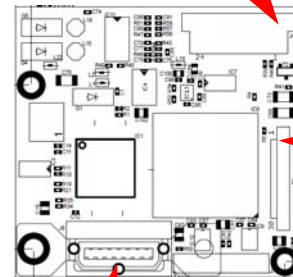

J8  
 DVI Output (HDMI connector)

J3  
 LVDS Video In,  
 Power, Serial Ctrl,  
 0.4mm Pitch Micro  
 Coaxial Cable

### PCB Bottom Side:

YpPr, CVBS  
 Output  
 J5  
 TL7052 has no  
 MCX connectors

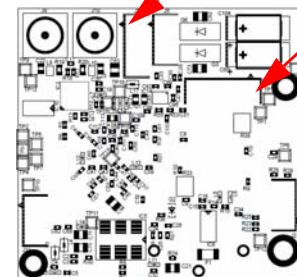

Power  
 RS232  
 TTL  
 Shutdown  
 J1

Note: Arrowheads indicate pin 1 location

J6: Do not connect  
 J7: Do not connect  
 J11: Do not connect

### SAFETY NOTES:

FFC with contacts on SAME side MUST be used when connecting J4 of TL7052 to the camera.

All digital inputs are specified for maximum voltages of 3.3V (+5%).

## Pin Assignment of external Interfaces

**J8 HDMI connector type is Kycon KDMI X\_FS1V\_WS or equivalent**

\* for reset, pull to GND for one second or longer

\*\* requires TL705x extended cable kit

**J1 JST BM10B-SRSS-TB**

**Power and RS232/ TTL Control IF**

- 1 DC IN
- 2 DC IN
- 3 GND
- 4 GND
- 5 Reset / Shut Down, pull to GND to reset/shut down TL7050 and camera\*
- 6 GND
- 7 TXD\_TTL (serial IF transmit, 3.3V) and/or temperature alert output
- 8 RXD\_TTL (serial IF receive, 3.3V)
- 9 RXD\_232 (serial IF receive, RS232 level)
- 10 TXD\_232 (serial IF transmit, RS232 level)

**Note: Connect RS232 or TTL serial interface, not both**

**J5 JST BM08B-SRSS-TB, analog video from FCB-EHxxxx**

**Analog component YPbPr and CVBS output \*\***

- 1 Pr
- 2 GND
- 3 Pb
- 4 GND
- 5 Y
- 6 GND
- 7 CVBS
- 8 GND

## Onboard Mode Switches

Switch	OFF (default)	ON
1 - cam select	FCB-EV cameras	FCB-EH
2 - cam control	RS232/TTL	do not use
3 - temp alert enable	no alert on J1/ pin7	J1/pin7 alert enabled
4 - mode	Camera	Test pattern*

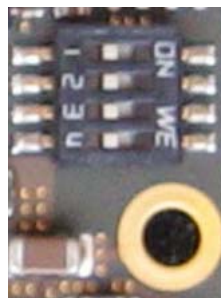

**Table 1: Onboard Switch Functions**

\* Refer to page 7 for test pattern generator operation

**POWER INPUT:**

5V DC regulated (5.8V DC absolute maximum) when using FCB-SE600

7V to 12V DC regulated (13V DC absolute maximum) for other camera blocks

**SAFETY NOTES:** FFC with contacts on SAME side MUST be used when connecting J4 of TL7052 to the camera. All digital inputs are specified for maximum voltages of 3.3V (+ 5%).

**Connection Diagram for FCB-EV, FCB-EH and -SE600 Camera Blocks**

TL7052 top side

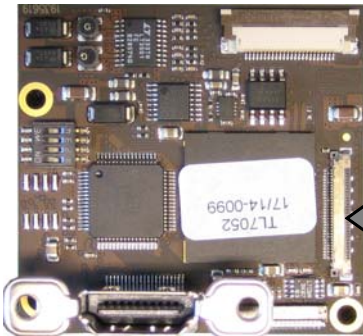

FCB-EV, FCB-EH or FCB-SE600



30pin micro coaxial cable is included in TL705x base cable kit.

TL7052 bottom side

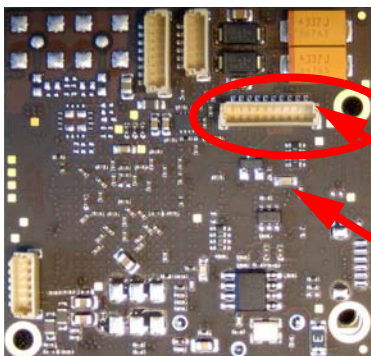

J1, 12V DC Power input, Reset and RS232/ TTL serial interface

Pin 1 location

Temperature alert signalling LED (red colour when on)

**Temperature Alert Function**

When board temperature exceeds 80°C (176°F), red LED will be switched on.

In addition such an event can be signalled on connector J1/pin7 by setting switch 3 (temp alert enable) to ON position.

- In case board temperature is equal to or over 80°C (176°F), level on J1/pin7 will be held constant low (< 0.4V)
- In case board temperature is less than 80°C (176°F), level on J1/pin7 will be high (> 2.4V)

**POWER INPUT:**

5V DC regulated (5.8V DC absolute maximum) when using FCB-SE600  
7V to 12V DC regulated (13V DC absolute maximum) for other camera blocks

**SAFETY NOTES:** FFC with contacts on SAME side MUST be used when connecting J4 of TL7052 to the camera. All digital inputs are specified for maximum voltages of 3.3V (+5%).

## Video Standard Selection Tables for FCB-EV Solutions

The video standard provided by the camera is automatically detected by the TL7052 module.



Camera Setting	TL7052 Output Format	Camera Support
1080i / 50Hz	1080i / 50Hz	FCB-EV7500/7310/7300/7100
1080i / 59.94Hz	1080i / 59.94Hz	FCB-EV7500/7310/7300/7100
1080i / 60Hz	1080i / 60Hz	FCB-EV7500/7310/7300/7100
1080p / 25Hz	1080p / 25Hz	FCB-EV7500/7310/7300/7100
1080p / 29.97Hz	1080p / 29.97Hz	FCB-EV7500/7310/7300/7100
1080p / 30Hz	1080p / 30Hz	FCB-EV7500/7310/7300/7100
1080p / 50Hz	1080p / 50Hz	FCB-EV7500/7310/7300/7100
1080p / 59.94Hz	1080p / 59.94Hz	FCB-EV7500/7310/7300/7100
1080p / 60Hz	1080p / 60Hz	FCB-EV7500/7310/7300/7100
720p / 50Hz	720p / 50Hz	all FCB-EV
720p / 59.94Hz	720p / 59.94Hz	all FCB-EV
720p / 60Hz	720p / 60Hz	all FCB-EV
720p / 25Hz	720p / 25Hz	all FCB-EV
720p / 29.97Hz	720p / 29.97Hz	all FCB-EV
720p / 30Hz	720p / 30Hz	all FCB-EV

**Table 2: Video output matrix for TL7052 with FCB-EV**

Camera Monitoring Mode Setting	Camera Register[74] Value (LVDS Mode)
1080p / 59.94Hz or 50Hz	01
All others modes	00

**Table 3: Required Camera Register[74] Settings for 1080p59.94Hz and 1080p50Hz operation**

**Notes:**

Refer to Sony FCB-EV manuals on camera operation and setting adjustments

Refer to Sony FCB-EH and FCB-SE600 series technical manuals for model specific video standard support

**POWER INPUT:**

5V DC regulated (5.8V DC absolute maximum) when using FCB-SE600  
 7V to 12V DC regulated (13V DC absolute maximum) for other camera blocks

**SAFETY NOTES:** FFC with contacts on SAME side MUST be used when connecting J4 of TL7052 to the camera. All digital inputs are specified for maximum voltages of 3.3V (+5%).

## Analog Video Output

TL7052 provides analog HDTV YPbPr and analog SDTV CVBS video output signals. These signals are directly taken from the camera.

In some camera modes no or only limited analog video output might be available. Please refer to the related camera documentation.

## Reset Operation

When applying power to TL7052, the camera is also automatically powered. During power up all functions on TL7052, are reset and initialized.

During operation a manual reset can be applied by pulling pin no. 5 of connector J1 to 0V (GND). This resets also the camera.

## Camera Control

Camera control can be done by connecting a PC or CCU via RS232 or serial 3.3V TTL interface to TL7052. The interface is passed through to the camera that all VISCA protocol based software can be used.

Serial interface selection must be done by appropriate setting of switch-2.

## Cable Kit Contents

### TL705xCK-B, Base cable kit:

#### External connecting cables:

1 pcs. - 10pin flying leads cable for power and control (RS232/TTL), lead length = 15cm / 5.9inch

#### Camera connecting cables:

1 pcs. - 30pin KEL USL type micro coaxial cable, connector on both sides, length = 20cm / 7.86inch

### TL705xCK-E, Extended cable kit for solutions with analog video breakout support:

#### External connecting cables:

1 pcs. - 8pin flying leads cable for analog video, lead length = 15cm / 5.9inch

#### Camera connecting cables:

1 pcs. -24pin flat flex cable, contacts on same side, pitch = 0.5mm, length = 10cm / 3.9inch

### POWER INPUT:

5V DC regulated (5.8V DC absolute maximum) when using FCB-SE600

7V to 12V DC regulated (13V DC absolute maximum) for other camera blocks

**SAFETY NOTES:** FFC with contacts on SAME side MUST be used when connecting J4 of TL7052 to the camera. All digital inputs are specified for maximum voltages of 3.3V (+5%).



## Test Pattern Generator

TL7052 has an integrated test pattern generator (TPG) which can be operated independent of any camera. The TPG can be enabled by setting onboard switch number 4 to ON position and repowering the TL7052 board. In addition one out of two test pattern and one out of four video standards can be selected by setting onboard switches 1, 2 and 3 accordingly. The following tables summarize all details.

To enable TPG mode, please execute these steps:

1. Set video mode with switches 2 and 3
2. Set pattern with switch 1
3. Set switch 4 to ON to enable TPG mode
4. Switch TL7052 power off and on again

Note: For TPG operation on TL7052 camera must be connected.

Switch	OFF	ON
4 (TPG on/off)	Camera video output	TPG video output
1 (Pattern)	Multi test pattern	Stress test pattern

Table 4: TPG on/ off and pattern select

	Switch 3 OFF	Switch 3 ON
Switch 2 OFF	1080p 59.94Hz	1080p 50Hz
Switch 2 ON	1080p 29.97Hz	1080p 25Hz

Table 5: Video standard selection

## Test Images

Multi Test Pattern

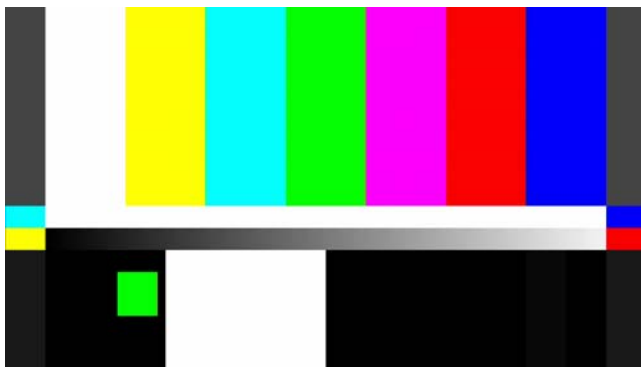

Stress Test



Stress test pattern generates worst case bit cycles on the serial 3G/HD-SDI link. It is suitable to check data/clock recovery performance of any connected 3G/HD-SDI receiver.

**POWER INPUT:**

5V DC regulated (5.8V DC absolute maximum) when using FCB-SE600

7V to 12V DC regulated (13V DC absolute maximum) for other camera blocks